

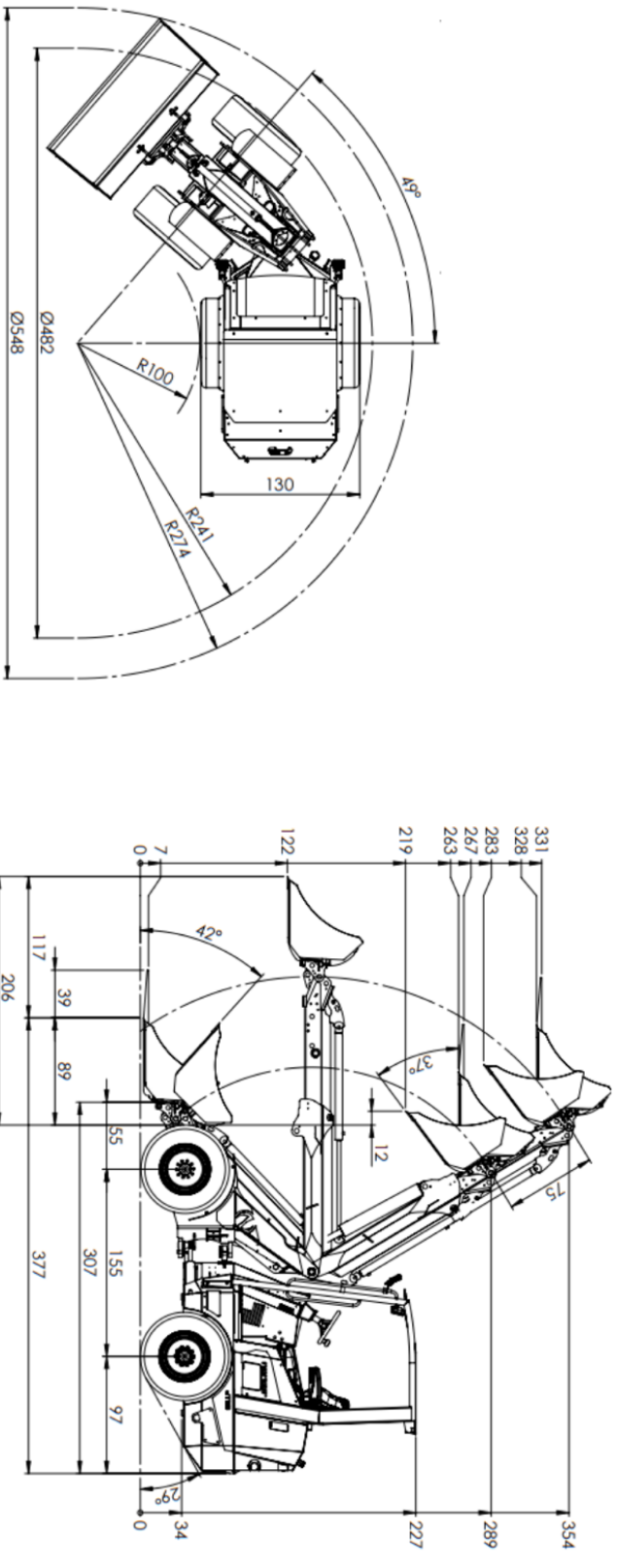

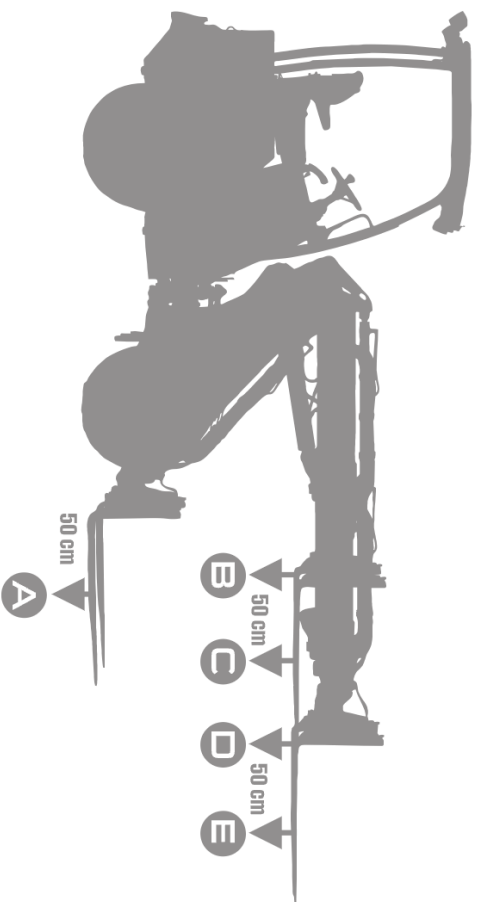

















Maat



Kiplast



A.		1950		1560		2100*		1900
B.		2200		1500		2400*		2000
C.		1500		1150		2150		1480
D.		1250		870		1660		1100
E.		1000		700		1350		930

+364 kg

*Hydraulisch gelimiteerd

